

# REX Regulator and Oral Nasal

## Contents

<b>REX-1</b>	<b>1.1 Regulator Performance</b>	<b>REX-6</b>	1.3.2 Cleaning Instructions
REX-1	1.1.1 REX® Regulator	<b>REX-7</b>	<b>1.4 REX® Regulator Re-Assembly</b>
REX-1	1.1.2 Kirby Morgan Tools for the REX® Regulator	<b>REX-13</b>	<b>1.5 Testing the REX® Demand Regulator for Proper Adjustment</b>
<b>REX-2</b>	<b>1.2 REX® Demand Regulator &amp; Exhaust System Post Dive Cleaning &amp; Sanitizing</b>	<b>REX-14</b>	1.5.1 REX® Adjustment Troubleshooting
REX-2	1.2.1 REX® Exhaust	<b>REX-15</b>	<b>1.6 Reinstalling the Regulator onto the Helmet</b>
REX-3	1.2.2 Demand Regulator & Exhaust System Post Dive Cleaning & Sanitizing	<b>REX-17</b>	<b>1.7 Oral Nasal Mask</b>
REX-3	1.2.3 Post Dive Disassembly	REX-17	1.7.1 Oral Nasal Mask Removal
REX-4	1.2.4 Sanitizing	REX-17	1.7.2 Inspection of Oral Nasal Mask and Valve
REX-5	1.2.5 Post Dive Reassembly	REX-17	1.7.3 Oral Nasal Replacement
<b>REX-6</b>	<b>1.3 Cleaning REX® Regulator Parts</b>		
REX-6	1.3.1 Precautions for Cleaning		

## 1.1 Regulator Performance

### 1.1.1 REX® Regulator

The Kirby Morgan REX® regulator offers extremely high performance. This regulator has been tested at Dive Lab in Panama City, Florida. It meets or exceeds all current U.S. Navy and European diving standards.

### 1.1.2 Kirby Morgan Tools for the REX® Regulator



*A Kirby Morgan tool kit, Part #525-768 is available that will assist you in removing and adjusting the REX® regulator. This kit ships with every KM 77 and 47 helmet.*

Use a brush with a soft handle, made from brass or plastic, to avoid damage to the critical internal bore of the main tube when cleaning it.

## 1.2 REX® Demand Regulator & Exhaust System Post Dive Cleaning & Sanitizing

Purpose: this procedure should be performed at completion of diving operations and/or whenever the helmet is to be used by another diver.

### Tools required:

- Small Flat Blade Screwdriver
- Small Cutting Pliers
- Clean Wiping Rag
- Nylon Tooth Brush
- Regulator Cover Spanner Wrench  
P/N 540-551
- Spray Bottle with Mild Dish Soap Solution
- Spray Bottle with Antiseptic Cleaner

### 1.2.1 REX® Exhaust

To sanitize the breathing system properly, the regulator cover and diaphragm must be removed so that the interior of the regulator can be cleaned and sanitizing solution can be flushed through the exhaust valve and whiskers.

1) Remove the regulator cover retaining ring (using the regulator cover removal tool) to begin removal of the cover.



*Start removal of the cover by unscrewing the retaining ring.*

2) If necessary, peel the regulator cover back from the retaining ring. Remove the ring.



*Remove the retaining ring and regulator cover.*

3) Remove the diaphragm and washer.



*Remove the diaphragm and washer.*

4) Sanitize the regulator interior and flush sanitizing fluid through the whiskers. Rinse with fresh water.

5) Reinstall the diaphragm, washer, cover, and retaining ring.

6) Tighten the retaining ring until snug. The lip of the main whisker body should completely cover the retaining ring, holding it in place.

**1.2.2 Demand Regulator & Exhaust System Post Dive Cleaning & Sanitizing**

Purpose: this procedure should be performed at completion of diving operations and /or whenever the helmet is to be used by another diver.

**Tools required:**

- Small Flat Blade Screwdriver
- Small Cutting Pliers
- Clean Wiping Rag
- Nylon Tooth Brush
- Regulator Cover Spanner Wrench  
P/N 540-551
- Spray Bottle with Mild Dish Soap Solution
- Spray Bottle with Antiseptic Cleaner

**1.2.3 Post Dive Disassembly**

1) Remove the regulator cover retainer using the cover removal tool, then pull out the cover, washer and diaphragm.

2) Remove the nose block device by loosening the packing nut, removing the knurled knob and sliding the shaft out through the oral nasal mask.



*Remove the regulator cover to inspect the diaphragm.*

3) Remove the microphone from the oral nasal mask then remove the oral nasal mask from the helmet.

4) Using small cutting pliers, carefully cut and remove the two tie wraps then pull the whiskers away from the main REX® whisker body.

5) Using the soap solution, wet the exhaust valves and seats, including the water dump valve and valve seat surfaces, as well as all surfaces exposed to the diver’s exhaled breath. The water dump valve can be difficult to see so take extra care to be sure it is cleaned. Agitate surfaces with the rag and/or brush, then rinse with clean water.

Make sure the solution flows through the rear of the regulator where the oral nasal mask attaches to the mount nut. This will help to ensure the exhaust valve in the regulator gets cleaned.

6) After cleaning with soap, wet components and surfaces of the regulator, oral nasal mask, water dump, whisker internals, and microphone with

the sanitizing solution. Carefully inspect for any obvious signs of deterioration or damage, replace any components in question.

### 1.2.4 Sanitizing

Sanitizing is done to minimize the spread of germs. The helmet should be sanitized daily when used by one diver, and between dives when used by multiple divers.

To maximize germ killing action, all internal surfaces that come into contact with exhaled gas need to be thoroughly wet with the sanitizing solution and kept wet for at least ten minutes, then thoroughly rinsed.

1) Wet the oral nasal mask, microphone, and oral nasal valve assembly, wipe and agitate all components and surfaces with the damp rag and allow to stay wet for a minimum of ten minutes to maximize germ killing action, then rinse thoroughly.

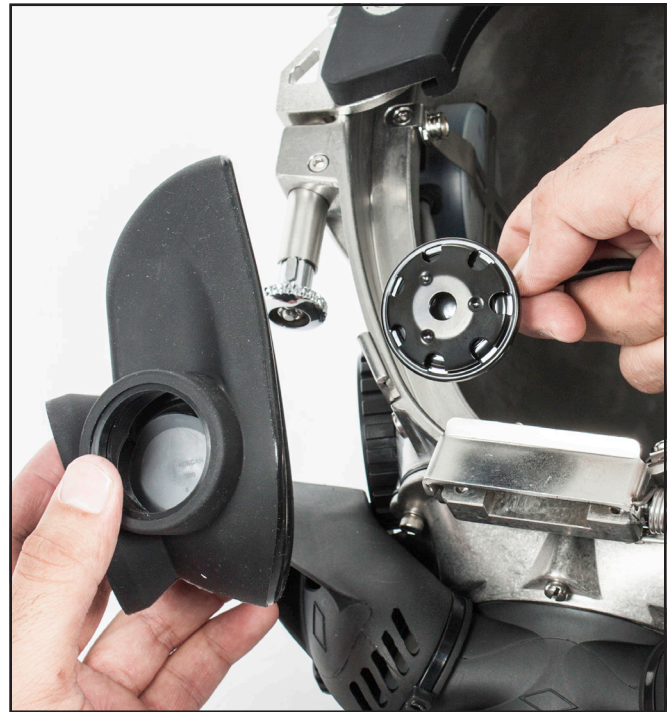

*Remove the microphone so you can remove the oral nasal mask.*

*The REX® Demand Regulator & Exhaust System*

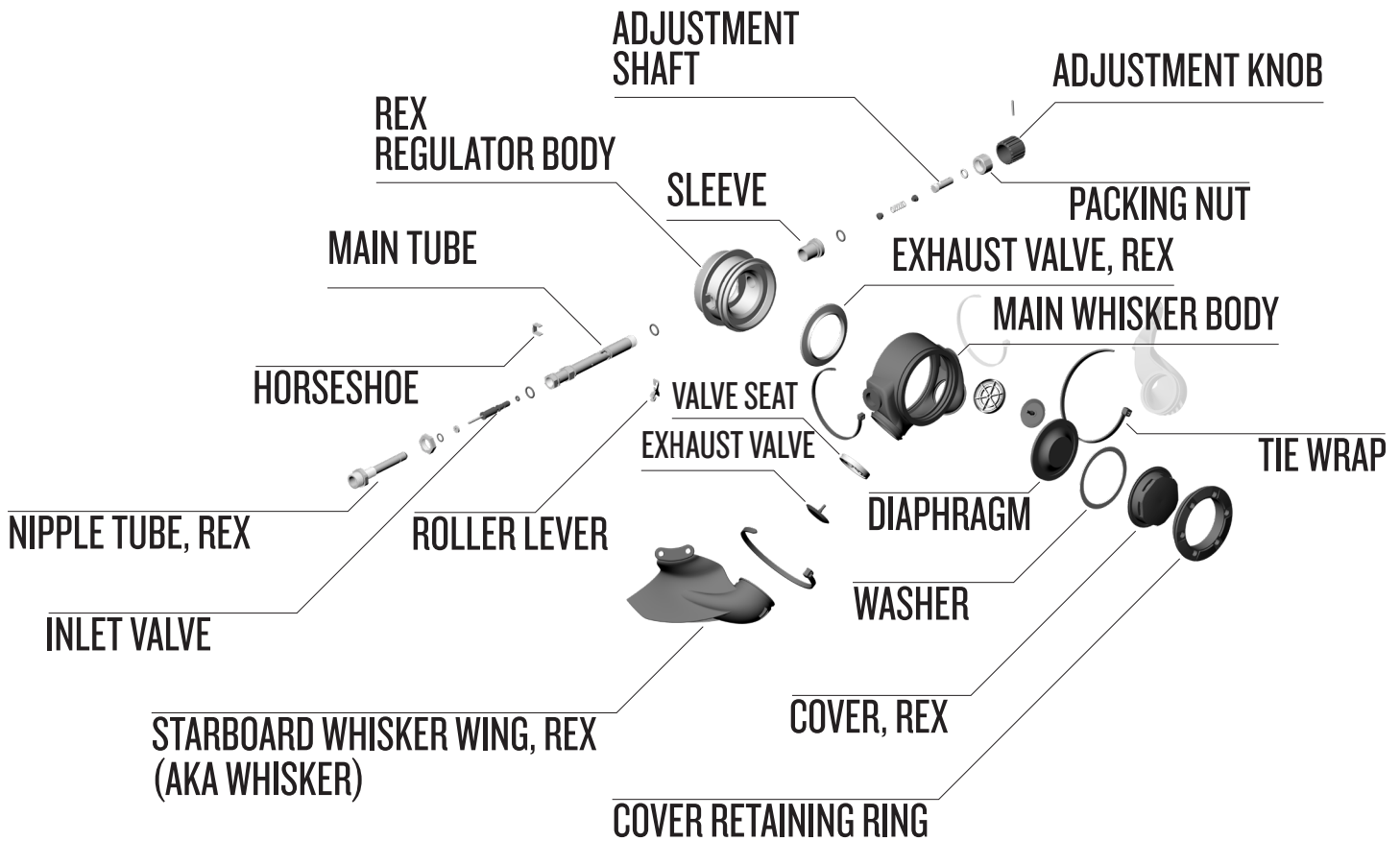



*Inspect the exhaust valves on a regular basis.*

**1.2.5 Post Dive Reassembly**

1) Reinstall the oral nasal mask onto the regulator mount nut, then lightly lubricate the nose block shaft with silicone, install, and secure by wrapping the knurled knob with a rag and tightening with pliers while holding the pad end.

Lightly tighten the packing nut, only tight enough so that it cannot be loosened by hand.

2) Install the microphone into the oral nasal mask then check to make sure the oral nasal valve is installed so the valve opens into the mask.

3) Reinstall both whisker valves ensuring the valves open outward away from the regulator body. It is extremely important they be installed in the correct orientation.

4) Install the diaphragm, washer, soft cover and cover retaining ring. Start the ring by running it in one to two turns, using the regulator cover spanner wrench, just enough to hold it in place

5) Be sure the main whisker body that surrounds the regulator body captures the cover retaining ring. A light application of silicone lubricant along the inside edges of the retaining ring can make this easier. A flat, non-metal, blunt object such as a tongue depressor or Popsicle® stick may be used to adjust the rubber seal flap onto the main whisker body. Once this is done, finish tightening the ring using the regulator cover spanner wrench.

6) Install the left and right whiskers then inspect and install the tie wraps.

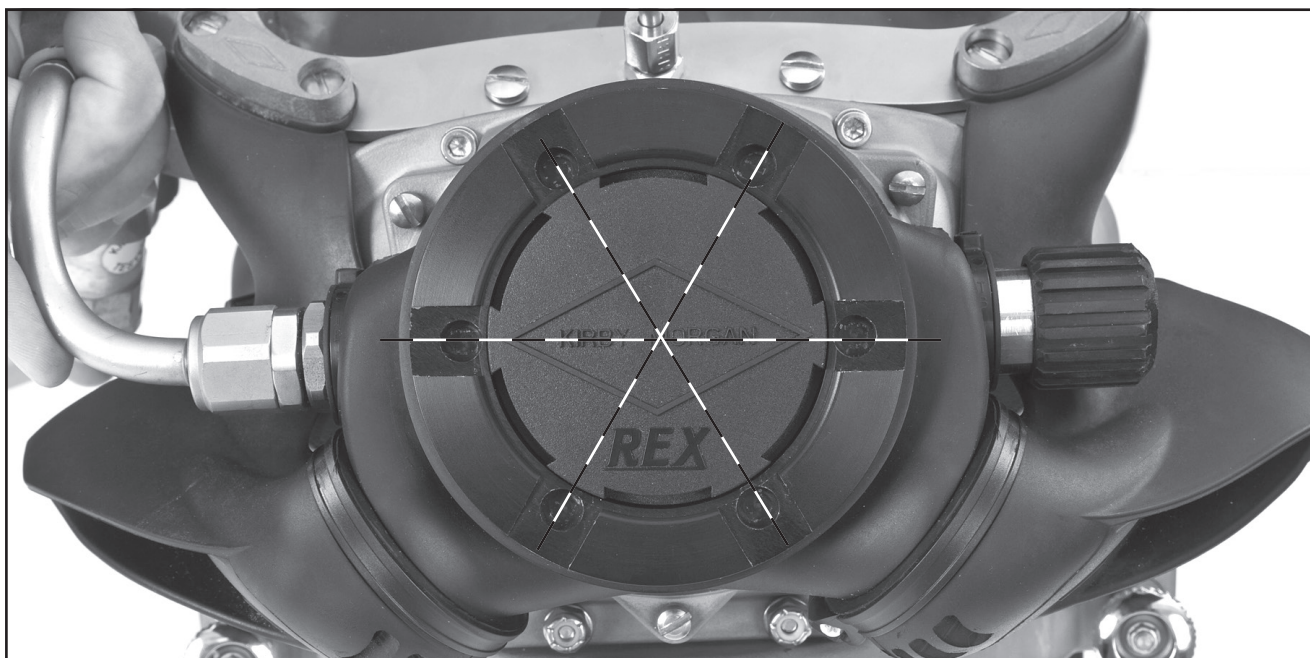

*When the retaining ring is properly installed, the cover should be oriented so that the Kirby Morgan name is level on the cover. If an imaginary line is drawn through the Kirby Morgan name, it will bisect the holes on opposite sides of the retaining ring. Note the alignment of the other holes on the ring relative to the slots in the regulator cover. This will help ensure proper water flow over the diaphragm and avoid trapping debris under the cover when working in water where there is suspended matter.*

Place tie-wraps around the tie wrap grooves in each of the two whiskers. Before doing the final tightening of the tie wraps make sure that the parting line on the bottom of the wings is lined up with the parting line on the main body, and the heads of the tie wraps are positioned on the back of the body.

Once this is done, finish tightening the cover retaining ring using the spanner wrench for the regulator cover.

Properly re-align the port and starboard wings to the main body.

### **⚠ WARNING**

**The exhaust valve inserts must be installed in the correct orientation in whisker main body. If the inserts are installed backwards, the diver will be unable to exhale. This could lead to suffocation and death.**

### **⚠ WARNING**

**The exhaust valves must be correctly installed in the exhaust valve inserts or they will not seal correctly. This could lead to a backflow of water into the helmet, which could expose the diver to contaminants that are in the water. Depending on the properties of the contaminants, this could lead to serious personal injury or death.**

### **⚠ WARNING**

**It is essential to ensure that the whisker encloses the outer lip of the regulator ring. If this does not happen, the retainer ring could possibly come unscrewed underwater. This would allow the diaphragm to fall out and the helmet would flood. This could lead to serious personal injury or death.**

## 1.3 Cleaning REX® Regulator Parts

### 1.3.1 Precautions for Cleaning

The inlet valve of the REX® requires frequent cleaning and lubrication due to the exacting tolerances of the inlet valve mechanism. Once fa-

miliar with this procedure the task can be accomplished in about 10-15 minutes. The following procedure is intended as a routine maintenance of the inlet valve mechanism. If an annual overhaul is being done, replacement of all O-rings is required.

### **⚠ CAUTION**

**Use only mild soap such as hand dish washing soap. Use only a tube brush that does not have an exposed metal tip, or use an all plastic brush. A tube brush with hard metal components could scratch the plated surface of the balance chamber.**

### 1.3.2 Cleaning Instructions

- 1) Remove the O-rings from the main tube, inlet valve, adjustment shaft, inlet nipple.
- 2) Using a wooden tooth pick, carefully remove the inlet valve soft seat from the inlet valve. Inspect the inlet valve for excess wear or damage. Follow replacement procedures if necessary. If the seat looks acceptable, simply clean and lubricate prior to reassembly.
- 3) Carefully clean all regulator components using a solution of dish soap and water, remove corrosion by soaking for 15-30 minutes in a 50/50 solution of vinegar and water. A tube brush should be used to clean the inside of the main tube.

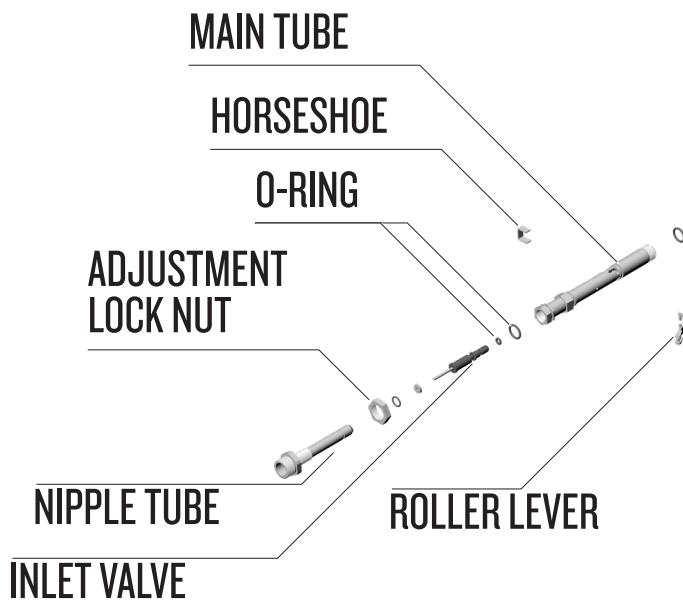

*Use extreme care when cleaning the nipple tube and main tube to avoid damage.*

Use care not to scratch the metal surfaces with the end of the tube brush. Use a soft nylon brush on all other surfaces. After cleaning rinse thoroughly with warm fresh water and blow or air dry.

4) Lay out all components and carefully inspect using a bright white light for signs of damage. Replace any components in question; re-clean any components that show signs of contamination.

When completing a scheduled overhaul, always replace the diaphragm, exhaust valves and O-rings. Replace any and all components that show signs of wear or damage.

5) Inspect the inlet valve to ensure the area where the soft seat lays is clean and free of old silicone sealant. If damage to the inlet valve seat is discovered, the seat can be replaced to return the assembly to good working order. Use a wooden toothpick to clean out the small vent hole of old silicone sealant.

**NOTE:** If you are replacing the inlet valve seat, be sure to perform this step at least 12 hours prior to rebuilding the regulator, so the silicone sealant will have time to dry.

**⚠ CAUTION**

**Use extreme caution when cleaning the balance chamber. A brush with hard metal components could damage the balance chamber.**

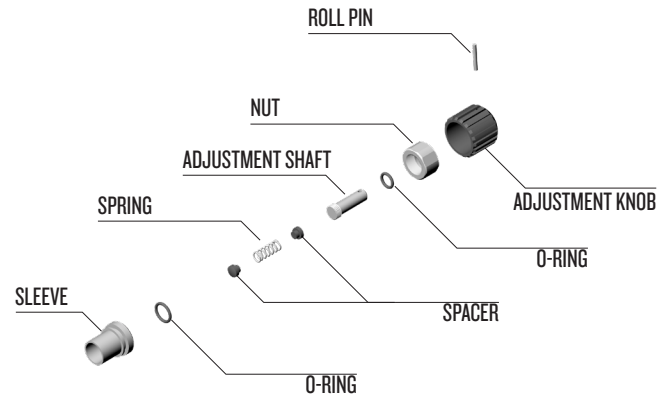

*The adjustment system must be clean and properly lubricated to turn freely.*

## 1.4 REX® Regulator Re-Assembly

### Tools required:

- Loctite® 248 or equivalent medium strength thread locker
- Christo-Lube® or equivalent oxygen compatible lube
- Torque Screwdriver
- ¼ inch flat blade screwdriver attachment
- (2) 13/16 inch open end wrenches or
- Back up wrenches found in tool kit P/N 525-613
- Torque Wrench
- 1¼, 13/16 inch Open End Attachment
- Cutting Pliers
- 3/8 inch Drive Extension—Minimum 3" in Length
- Regulator Mount Nut Tool P/N 325-640
- Regulator Cover Spanner Wrench P/N 540-551

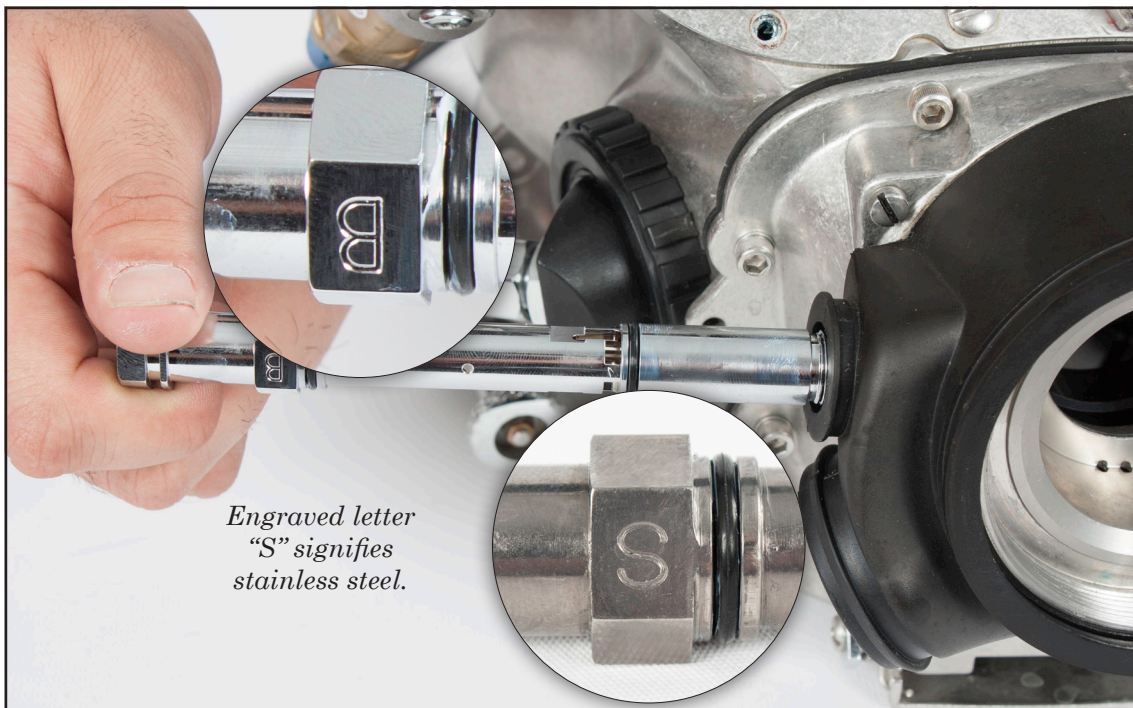

*Note the engraved letter “B” on the main tube. It must face outwards, away from the helmet to be installed properly. Soon, the REX® regulator will have the main tube machined from stainless steel. These will be marked “S” in the same location*

**NOTE:** If you are replacing the inlet valve seat, this must be done at least 12 hours before installing it in the regulator.

1) Place a very thin film of silicone sealant on one side of the inlet soft seat then install it, sealant side down, onto the inlet valve and press firmly and evenly to fully seat. The sealant must be allowed to dry completely (at least 12 hours) before re-installing and adjusting.

2) Install the O-ring onto the inlet valve, then lightly lubricate.

3) Install the exhaust valve onto the regulator body. Ensure that the valve is not wrinkled and lays flat against the seat area. Make certain this valve is not installed upside down. Check proper positioning and seating by blowing clean air up through the valve. Be certain the valve does not stick open after doing so.

4) Insert the sleeve into the left side of the exhaust whisker body. Make certain the groove in the sleeve aligns with the mating rubber area of the whisker main body to allow proper sealing. When properly installed, the end of the sleeve will be just inboard of the main body end.

5) Hold the main whisker body so the two valve ports are facing down and the large opening on the back side is facing you. Install the regulator body into the main whisker body with the round inlet tube hole on the left as you are looking into the body.

**NOTE:** Leave the port and starboard whiskers off until after the regulator body with the main whisker body are installed onto the helmet.

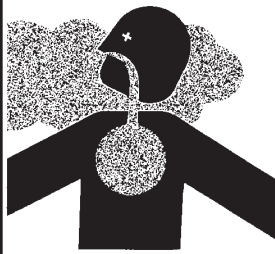
<b>⚠ CAUTION</b>	
	<p><b>Use good ventilation when using RTV sealant. Fumes from this material may irritate your lungs. Read and follow the directions in the MSDS before using this material.</b></p>

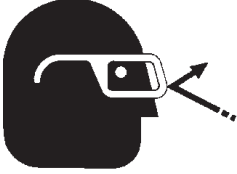

<b>⚠ CAUTION</b>	
	<p><b>Wear hand protection when using RTV sealant. This material may irritate your skin. Read and follow the directions in the MSDS before using this material.</b></p>

<b>⚠ CAUTION</b>	
	<p><b>Wear eye protection to prevent cleaning and germicidal cleansing solutions from contacting eyes. If contact occurs, rinse eyes with large amounts of water and consult medical help immediately.</b></p>

6) Inspect the regulator mount nut for contaminants or damage. You may use a toothbrush to clean the threads as necessary.

**NOTE:** Carefully inspect the water purge exhaust valve located inside the lower groove, just below where the oral nasal will sit. It is very important this valve is oriented correctly and free of debris. CO<sub>2</sub> buildup can occur if not correctly installed and clean.

7) Install the regulator body with the main whisker body and sleeve onto the helmet.

**NOTE:** Be certain the regulator cover, washer, diaphragm and exhaust valve are not in place before installing the regulator body with whisker body. Otherwise, there may be problems aligning the main whisker body.

Feed the regulator body into the helmet (KM 47) or into the regulator mount pod (Stainless Steel helmets), threading the regulator mount nut on, hand tight only.

**Stainless steel:** Work around the edge of the whisker where it meets the shell to align the rubber grooves at the back of the whisker to the

grooves on the pod. The whisker should have a straight angled surface from the pod towards the outer edge of the regulator. Loosen the mount nut as needed if re-alignment is necessary. There should be no gaps between the main whisker body and the pod mount area.

**Stainless & KM 47:** Make sure the cross hole for the main tube is as level as possible. This will allow for easier alignment of the bent tube. Once all is aligned and no gaps are found, finish tightening the regulator mount nut, see “Torque Specs” on page APNDX-19 for correct torque.

8) Use Christo-Lube® or equivalent oxygen compatible lube to lightly lubricate the threads on the regulator mounting tube.

9) Lightly lubricate the two O-rings for the main tube and install them onto the main tube.



*If you install a new seat on the inlet valve, you must allow the silicone sealant time to dry. Be sure the O-ring is properly installed on the valve body.*



*The roller lever is installed after the horseshoe is installed.*

11) Install the inlet valve into the inlet side of the main tube with the soft seat facing out. Ensure the valve is fully seated. Tilt the regulator up and shake as needed to position the inlet valve properly into the tube to accept the lever arm.

12) Install the roller lever into the main tube making sure to engage the slot in the inlet valve.

13) Press the main tube all the way into the body until the roller lever legs are up against the inside wall of the regulator body. To check for proper engagement, try shaking the inlet valve loose by tilting the regulator up and shaking it. If the inlet valve falls out, it was not properly engaged.

10) Install the main tube into the regulator body by installing the male threaded end into the side opposite of the sleeve installed previously. Push the tube in far enough to allow installation of the horseshoe. Install the horseshoe then rotate the main tube so the small vent hole at the middle of the tube will be facing up towards the diaphragm.



*The port and starboard whiskers should align so that the parting line on the bottoms of the wings is lined up with the parting line on the main body, and the heads of the tie wraps are positioned on the back of the body. You can also make marks on the whiskers with a felt tip pen.*

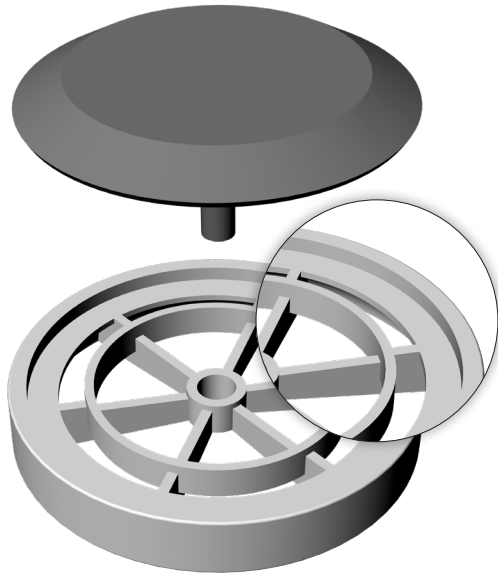

**Correct**

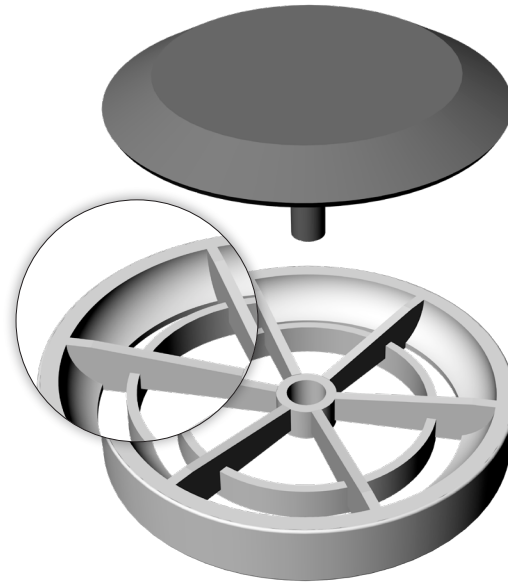

**INCORRECT**

*The exhaust valve inserts are recessed on one side to accept the exhaust valves so they sit flush in the inserts. The exhaust valves must be installed properly in the inserts or they will not seal or perform properly.*

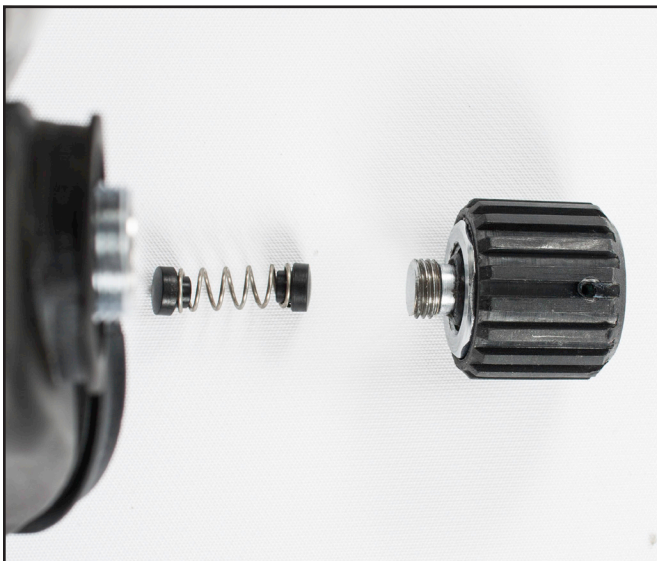

*The spring and spacers must be properly engaged.*

14) Lightly lubricate the two spring pads (spacers), and install them on both ends of the regulator adjustment spring. Insert this assembly into the adjustment side of the main tube. This is best accomplished if you hold the regulator so that the tube is vertical and the spacers and spring are pushed up into the tube.

15) Carefully inspect the threads on the adjustment shaft for damage then lubricate and install a new O-ring over the threads onto the shaft.

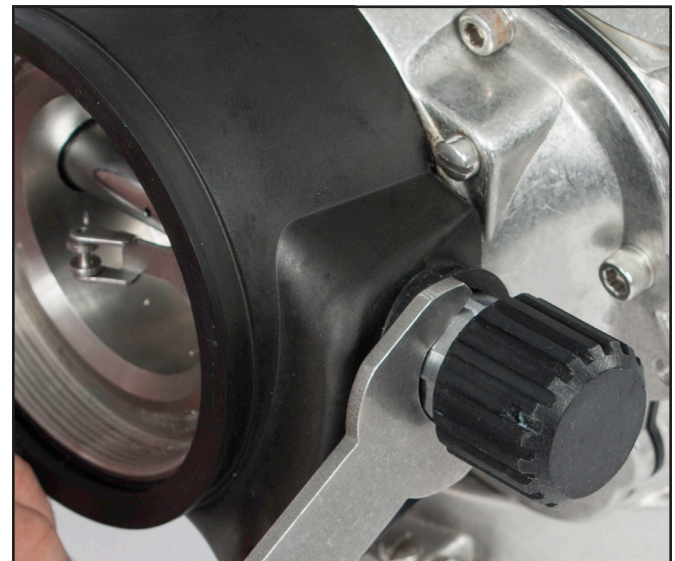

*Tighten the packing nut on the adjustment knob.*

16) Place a small amount of lubricant on the threads of the adjustment side of the main tube, then engage and install the adjustment shaft to the main tube as well as the packing nut onto the main tube. Run the adjustment shaft all the way in while at the same time rotating the packing nut all the way onto the main tube. Make sure the adjustment knob is turned in just far enough so only enough of the packing nut is exposed to accept a wrench.

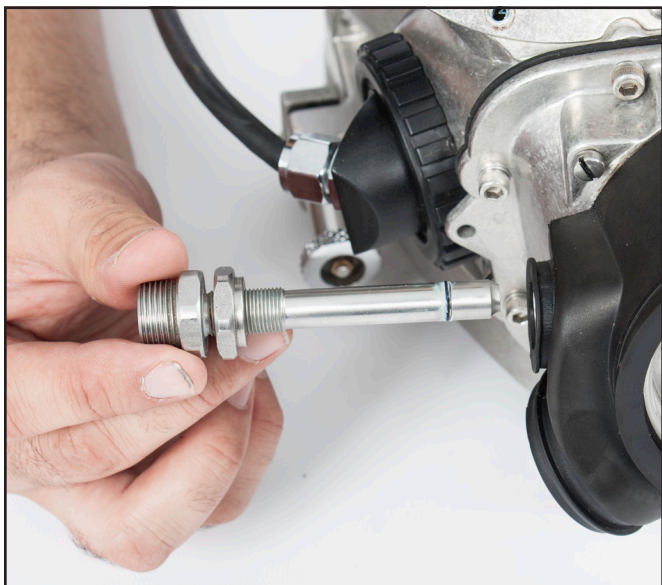

*Installing the nipple tube.*

17) Lightly lubricate and install a new O-ring onto the nipple tube, then install the nipple tube and rotate inwards for about ¼ inch.

18) Tighten the regulator packing nut see “Torque Specs” on page APNDX-19 for correct torque.

19) Make sure the rubber on the whisker body properly fits the matching groove on the main tube at the inlet side of the regulator. Install new tie wraps on both the adjustment and inlet sides of the exhaust whisker where it joins the main tube, securely tighten, then using side cutters, cut the excess tie wrap material.

20) Install a new de-watering valve. Take your time and make sure it is properly seated.

21) Carefully inspect the bent tube for damage and contamination. The bent tube must be free of dents and compressions deeper than ⅛ inch and should not have deep scratches or sever corrosion.

Replace the bent tube if questionable. Lightly lubricate a new O-ring and install on the regulator end of the bent tube. Install a new Teflon® washer on the side block end.

22) Inspect the exhaust valve inserts for damage and contamination. Install new valves, if neces-

sary, ensuring they are installed onto the correct side of the plastic body.

23) Install the whisker exhaust valve inserts into the whisker main body. Refer to the notation or marks made when the parts were disassembled.

24) Install the left and right whiskers, or whisker wings, then inspect and install the tie wraps.

Place tie-wraps around the tie wrap grooves in each of the two whiskers. Before doing the final tightening of the tie-wraps, make sure that the parting line on the bottom of the wings is lined up with the parting line on the main body, and the heads of the tie wraps are positioned on the back of the body.

Properly re-align the port and starboard wings to the main body.

25) Reinstall the 4 spacers, kidney plates or zinc whisker anodes and screws and torque see “Torque Specs” on page APNDX-19 for correct torque.

26) Screw the regulator adjustment knob in clockwise all the way, then rotate it out counter clockwise three turns.

27) Position the regulator so the lever arm is pointing upwards. Slowly rotate the inlet nipple in clockwise until a very slight movement is noticed at the roller lever then stop. Lightly tighten the jam nut to prevent movement of the nipple tube.

28) Install the bent tube into the inlet nipple, 3 or 4 turns. If needed, turn the regulator assembly on the helmet to allow alignment of the bent tube to the side block.

29) Lightly lubricate the male threads on the side block and swing the bent tube up into place and torque the bent tube to the side block. Using the two 13/16 inch wrenches from the regulator tool kit, hold the nipple tube to prevent it from rotating and tighten the bent tube nut against the nipple tube.

30) Install the diaphragm, washer, cover and cover retaining ring to the regulator assembly using the special spanner wrench.

The closed sections of the cover should align with the indentations in the retaining ring. See diagram on page REX-13 for a more detailed illustration of the proper relationship between the cover and the retaining ring.

**⚠ WARNING**

It is essential to ensure that the main whisker body encloses the outer lip of the regulator ring. If this does not happen, the retainer ring could possibly come unscrewed underwater. This would allow the diaphragm to fall out and the helmet would flood. This could lead to serious personal injury or death.



*Be sure to tighten the regulator mount nut to the proper torque specification see “Torque Specs” on page APNDX-19 for correct torque when the installation is complete.*

**1.5 Testing the REX® Demand Regulator for Proper Adjustment**

**Tools Required:**



*Cover*

*Tool slot*

*Retainer ring*

*Note position of gap*

*The REX® regulator must be properly assembled and installed for it to function correctly. Note the position of the regulator cover relative to the outer retaining ring. The gaps on the edge of regulator cover must be centered between the holes on the regulator cover retainer ring.*

- REX® Regulator Adjustment Tools (Tool Kit P/N 525-768)
- Low Pressure Air Source

Adjustment of the demand regulator should be done using a supply pressure of between 135–150 p.s.i.g. Use only breathing quality air with a regulated source.

1) Ensure that the steady flow defogger valve is fully shut.

2) With the regulator cover and diaphragm off. Run the bias adjustment knob all the way in, then back it out three turns.

3) Turn the inlet nipple adjustment, OUT, “Counter Clockwise” just enough to remove any play in the lever arm, then to get the proper lever arm setting, turn the nipple tube adjustment IN, “Clockwise” slowly until the lever just starts to move. Now stop and hand tighten the jam nut against the regulator body to stop the inlet valve from turning.

4) Slowly bring up the air pressure supply to between 135–150 p.s.i.g.

5) Back out on the bias adjustment knob counterclockwise until a slight free flow starts, then turn in clockwise until the flow stops and check the lever play. The lever should have between  $\frac{1}{16}$  inch– $\frac{1}{8}$  inch of free play (1.5–3mm).

6) To increase lever play, turn the inlet nipple in. To decrease play rotate the inlet nipple out. Once adjustment is achieved, securely tighten the inlet nipple jam nut against the regulator body.



*The regulator can be adjusted when it is on the helmet.*



*Check the adjustment of the regulator using the regulator adjustment knob.*

Repeat step 5 and 6 as necessary.

7) Make certain the bent tube fitting is snug against the hex on the nipple tube by again using two  $\frac{13}{16}$  inch wrenches. Re-check the purge adjustment and re-adjust if needed.

8) Check for proper free flow by turning the adjustment knob out till free flow starts, then back in until it stops.

### 1.5.1 REX® Adjustment Troubleshooting

**Problem:** Regulator hisses and will not shut off.

**Remedy:** Check to ensure the lever has between

1/16 inch and 1/8 inch play. To increase lever play, rotate the inlet nipple in clockwise.

**Remedy:** After checking for lever play, secure the air source. Remove the inlet nipple and check for nicks or flaws on the tip. Replace if needed and re-test. If leak persists, check the inlet seat for damage, check for damaged piston O-ring.

**Problem:** Bent tube damaged causing the nipple tube to be improperly aligned.

**Remedy:** Replace bent tube.

**Problem:** Depressing the regulator cover results in little or no flow.

**Remedy:** Slowly back out counterclockwise on the inlet nipple 1/8 turn, re-check, readjust as necessary.

## 1.6 Reinstalling the Regulator onto the Helmet

### Tools Required:

- Torque Wrench
- 3/8 inch Drive Extension—Minimum 3" in Length
- Regulator Mount Nut Tool P/N 325-640
- Flat Blade Torque Screwdriver
- 13/16 inch Open End Wrenches
- Loctite® 248 or equivalent medium strength thread locker

1) Install the washer and regulator assembly (without the whisker wings) into the helmet, threading the regulator mount nut as you feed the regulator assembly in, hand tight only.

2) Work around the edge of the main whisker body where it meets the helmet shell to align the rubber grooves at the back of the whisker, to the grooves on the pod (stainless steel helmet).

3) Ensure the whisker exhaust valve inserts are in place, with the valves oriented in the correct direction (Refer to image, top of page REX-11), then

install the port and starboard whiskers as described in step 24) on page REX-12.

4) Install the bent tube into the inlet nipple, three or four turns. If needed, turn the regulator assembly on the helmet to allow alignment of the bent tube to the side block.

5) Lightly lubricate the male threads on the side block and swing the bent tube up into place and torque the bent tube to the side block.



*Make sure the whisker spacers are in position before tightening the screws that secure the whiskers.*



*The whiskers are fastened to the face port using two screws on each side.*

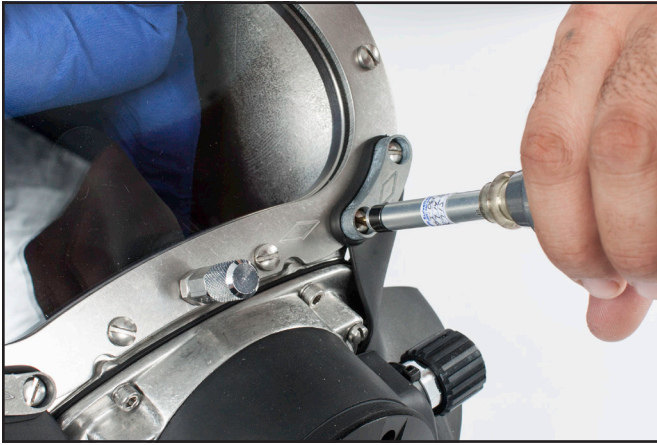

*Only use a torque screwdriver to tighten the screws that secure the whiskers to the face port.*



*The regulator mount nut must be tightened see "Torque Specs" on page APNDX-19 for correct torque. Use a torque wrench to ensure the correct setting.*

6) Install the diaphragm, washer, cover and cover retaining ring to the regulator assembly using the special spanner wrench.

7) The main whisker body should have a straight angled surface from the helmet shell towards the outer edge of the regulator. Realign if needed.

**Correct**

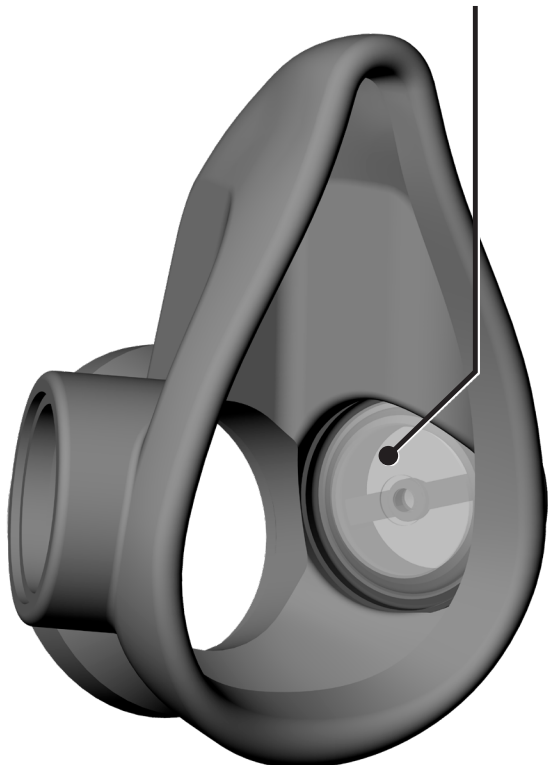

**INCORRECT**

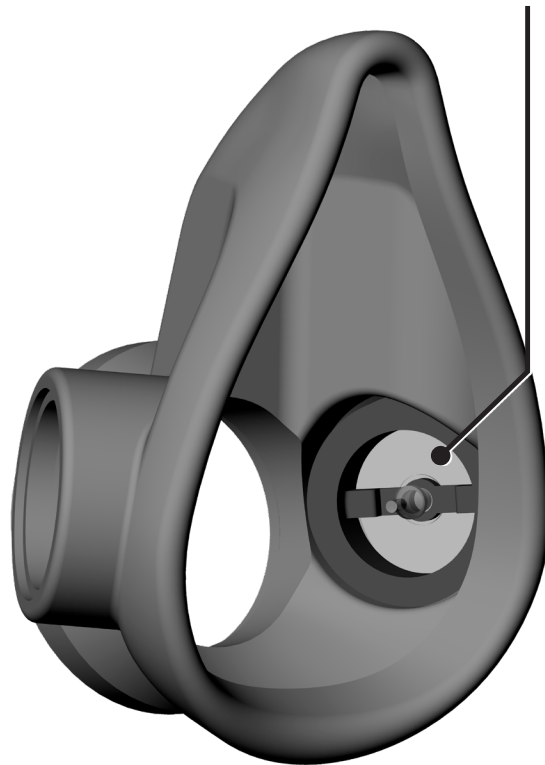

*Correct installation of the oral nasal valve is extremely important to your safety.*



8) Install the oral nasal mask per “1.7 Oral Nasal Mask” on page REX-17.

9) Install the microphone in the oral nasal mask per “1.3.5 Microphone Replacement” on page COM-5.

10) Install the nose block device per “1.2.2 Nose Block Device Replacement” on page FCPRT-6.

11) Install and tighten the whisker retainer screws see “Torque Specs” on page APNDX-19 for correct torque. Be sure to use a small amount of Loctite® to secure the screws. For stainless steel helmets, use Loctite® 248. For the KM 47 helmet, use Loctite® 222



*Make sure the connection between the bent tube and the regulator is snug.*

**⚠ WARNING**

**All parts on Kirby Morgan helmets and masks must be adjusted to their proper torque specifications. See Appendix 1 for a complete listing of torque specifications for each part. Failure to adjust parts to the recommended specifications could lead to helmet failure and accidents. This could be fatal.**

**⚠ WARNING**

**Avoid any contact between Loctite® and the face port. This can cause the port to fail unexpectedly and drowning could result.**

**1.7 Oral Nasal Mask**

**1.7.1 Oral Nasal Mask Removal**

**Tools Required:**

- 7/16 inch Open-End Wrench

The oral nasal mask is easily replaced.

1) Remove the nose block device first. See “1.2 Nose Block Assembly” on page FCPRT-6 for this procedure.

**⚠ CAUTION**

**The nose block device MUST be removed and reinstalled when installing a new oral nasal mask. Simply stretching the oral nasal mask over the nose block device can cause the oral nasal mask to tear.**

2) Remove the microphone.

3) The oral nasal mask can then be pulled off the regulator mount nut. It is held on by a snap fit.

**1.7.2 Inspection of Oral Nasal Mask and Valve**

1) Inspect the oral nasal mask. If it is torn, damaged, shows signs of cracking or age, it must be replaced.

2) Inspect the oral nasal valve. If the valve is in good condition, it may be reused.

**1.7.3 Oral Nasal Replacement**

1) Install the oral nasal valve body and valve into the oral nasal mask. This valve helps to reduce carbon dioxide build-up inside the helmet and must be in place. Make sure the oral nasal valve is installed in the correct orientation, to allow flow into the oral nasal mask. Refer to the image “Correct installation of the oral nasal valve is extremely important to your safety.” on page REX-16.

2) Snap the oral nasal over the regulator mount nut. On the KM 77, there is a tight fit between the mask and the pod at the top of the pod. Take

extra care to make sure the mask has snapped into position all the way around the mount nut.

3) Reinstall the microphone as per “1.3.5 Microphone Replacement” on page COM-5.

4) Reinstall the nose block device. See “1.2 Nose Block Assembly” on page FCPRT-6 for complete instructions on reinstalling the nose block device.